

# GUIDELINES FOR TEMPORARY SHORING



EMAIL BEFORE YOU DIG  
[UP.COM/CBUD](http://UP.COM/CBUD)

EMERGENCIES  
1-888-877-7267



CALL BEFORE YOU DIG  
1-800-533-2891

EMERGENCIES  
1-800-832-5452

# Contents

1. INTRODUCTION.....	2
1.1 PURPOSE .....	2
1.2 SCOPE .....	2
2. GENERAL CRITERIA .....	2
2.1 SAFETY & RAILROAD OPERATIONS .....	2
2.2 SHORING REMOVAL .....	2
2.3 RAILROAD FLAGGING.....	2
2.4 CALL BEFORE YOU DIG & EXISTING UTILITIES .....	3
2.5 APPLICANT & CONTRACTOR RESPONSIBILITIES.....	3
2.6 TRACK, GROUND & SHORING MONITORING:.....	4
2.7 RAILROAD RIGHT-OF-WAY .....	5
2.8 CONSTRUCTION AND MAINTENANCE AGREEMENT .....	5
2.9 RAILROAD REVIEW PROCESS .....	5
2.10 APPROVAL EXPIRATION.....	6
3. DESIGN.....	6
3.1 GENERAL DESIGN REQUIREMENTS .....	6
3.2 INFORMATION REQUIRED .....	8
3.3 DESIGN PROCEDURE .....	9
3.4 (Step 1) EXCAVATION LOCATION .....	9
3.5 (Step 2) SUBSURFACE CHARACTERIZATION .....	9
3.6 (Step 3) SHORING TYPES .....	11
3.7 (Step 4) APPLIED LOADS AND CALCULATIONS .....	12
3.8 (Step 5) STRUCTURAL DESIGN CALCULATIONS.....	19
3.9 DESIGN PLAN REQUIREMENTS .....	23
4. DEFINITIONS.....	24
5. APPENDIX .....	26
5.1 LIVE LOAD PRESSURE DUE TO COOPER E80 LOADING .....	26
5.2 CHART – LIVE LOAD PRESSURE DUE TO E80 LOADING .....	27
5.3 TABLES FOR SOIL SPECIFICATIONS .....	29
6. REFERENCES.....	30

# 1. INTRODUCTION

## 1.1 PURPOSE

- a. The purpose of these guidelines is to inform public agencies, design engineers, contractors and inspectors of current Railroad standards and requirements concerning design and construction of temporary shoring.

## 1.2 SCOPE

- a. This guideline governs on the Railroad Right-of-Way. This includes the limits of property owned, controlled and/or operated upon by the Railroad.
- b. All requirements addressed within this document shall constitute minimum requirements for all projects or works on the Railroad Right-of-Way. The applicability of each requirement for any given project will be subjected to the Railroad's discretion.
- c. Where laws or orders of authority prescribe a higher degree of protection or restriction than specified herein, the higher degree so prescribed shall control.
- d. These guidelines supplement the current American Railway Engineering and Maintenance-of-Way Association (AREMA) Manual for Railway Engineering. For items covered within these guidelines and AREMA, the more restrictive shall control.
  - i. **It is the requirement for the Contractor and designer developing Railroad shoring systems to have a copy of the AREMA Manual. Visit [www.arema.org](http://www.arema.org) to obtain the Manual for Railway Engineering.**
- e. These guidelines supersede all previous Railroad guidelines for temporary shoring and are subject to revision without notice.
- f. In addition to this guideline, all excavations shall also be governed by each individual Railroad requirements, Federal, State and Local laws, rules and regulations concerning construction safety.
- g. These guidelines are provided as a reference and cannot be taken as authority to construct without prior review and written approval of the Railroad. See [Section 2.9](#) for review process.

# 2. GENERAL CRITERIA

## 2.1 SAFETY & RAILROAD OPERATIONS

- a. Projects shall be designed such that construction activities and phasing will not compromise safety nor impact Railroad operations.
- b. Emergency Railroad phone numbers are to be obtained from a Railroad representative prior to the start of any work and shall be posted at the job site.

## 2.2 SHORING REMOVAL

- a. The Contractor is responsible for planning and executing all procedures necessary to construct, maintain and remove the temporary shoring system in a safe and controlled manner.

## 2.3 RAILROAD FLAGGING

- a. A flagman is required when any work is performed within 25 feet of track centerline. If the Railroad provides flagging or other services, the Contractor shall not be relieved of any responsibilities or liabilities as set forth in any document authorizing the work. No work is allowed within 50 feet of track centerline when a train passes the work site, and all personnel must clear the area within 25 feet of track centerline and secure all equipment when trains are present.

## 2.4 CALL BEFORE YOU DIG & EXISTING UTILITIES

- a. Call Before You Dig: Appropriate measures for the installation and protection of fiber optic, or other cables, shall be addressed in the plans and contract documents. For specific Railroad requirements and additional information refer to:

BNSF: [www.bnsf.com](http://www.bnsf.com) or call 1-800-533-2891.

UPRR: [www.up.com/cbud](http://www.up.com/cbud)

- b. Relocation of utilities or communication lines not owned by the Railroad shall be coordinated with the respective utility owners. Utility relocation plans must then be submitted to the Railroad utility representative(s) for review and prior approval must be secured before work can proceed. The Railroad will not be responsible for costs associated with any utility, signal, or communication line relocation or adjustments.
- c. Abandonment of utilities must follow the [UPRR Guidelines For Abandonment of Subsurface Utility Structures](#) or the [BNSF Utility Accommodation Policy](#).

## 2.5 APPLICANT & CONTRACTOR RESPONSIBILITIES

- a. The Applicant and Contractor must verify with the Railroad's Local Representative their receipt of the latest version of these guidelines prior to developing Construction Documents.
- b. Construction shall NOT impact Railroad operations, functions and facilities:
  - i. The Applicant and Contractor shall develop design plans, including, without limitation, all procedures necessary to construct and maintain the proposed shoring project, which cause no interruption to Railroad operations during and after construction.
  - ii. Work shall also not impede drainage or other functions of the Railroad.
  - iii. Any rail traffic outages or curfews thought to be required for the installation or removal of any portions of a shoring system must be requested by submittal to the Railroad for prior consideration long in advance of mobilization and construction. Such requests may not be granted.
  - iv. Unapproved and unscheduled interruptions to Railroad operations may result in your removal from Railroad Right-of-Way, and your authorization to re-enter revoked.
- c. Railroad approved design and construction plans:
  - i. The Contractor shall install the temporary shoring system per the plans approved by the Railroad.
  - ii. Any deviation from the Railroad approved plans requires resubmittal and prior approval by the Railroad prior to proceeding with said deviation. Approval from the Railroad may not be granted.
- d. The Contractor must monitor the track, ground and shoring for movement. See [Section 2.6](#) for monitoring.
- e. The Applicant and Contractor shall be jointly responsible for the design, construction and performance of the temporary structure.
- f. The Contractor must review the temporary shoring plans to ensure that the proposed method of construction is compatible with the existing site and soil conditions. Removal of the shoring system must also be addressed.
- g. The Contractor must obtain a valid right of entry permit from the Railroad and comply with all Railroad requirements when working on Railroad property.
- h. The Contractor is responsible to protect the Railroad ballast and subballast from contamination.
- i. The Contractor shall comply with all State and Federal Laws, county or municipal ordinances and regulations which in any manner affect the work.
- j. All removed soils will become the responsibility of the Contractor and shall be disposed of outside the Railroad Right-of-Way according to the applicable Federal, State and Local regulations.

- k. The project engineer and the Contractor shall evaluate the quality of materials furnished and work performed.
- l. The Applicant, at its expense, shall be solely responsible for all costs, design, construction, future replacement, maintenance, and serviceability of the proposed shoring project, except as noted otherwise in the Construction & Maintenance (C & M) Agreement with the Railroad.
- m. The Applicant shall be responsible for obtaining all Federal, State, Local and other permits for construction of the shoring project.
  - i. The Engineer-of-Record shall be registered in the state of the project location. The Engineer-of-Record may be Applicant's in-house staff or a consultant retained by the Applicant. The Contractor shall not employ the Engineer-of-Record as the Contractor's Engineer-of-Record or as a specialty engineer, with the exception of design build projects.
- n. The Applicant and/or the Engineer-of-Record have the ultimate responsibility and liability for the Construction Documents and liability for damages to Railroad property during and after construction of the shoring.
- o. The Contractor is responsible to comply with the construction documents prepared by the Applicant. The Contractor shall comply with Railroad requirements stated in the C & M Agreement prior to the commencement of any construction. The Contractor shall develop work plans that ensure the track(s) remain open to train traffic per Railroad requirements as stated in the C & M Agreement and meet the requirements of the Railroad Right-of-Entry Agreement (if applicable).
- p. The Applicant and Contractor is responsible for the security and safety of all people including the general public and trespassers, and the protection of Railroad infrastructure within the limits of the proposed shoring project. Any damage to Railroad property such as track, signal equipment or structure could result in a train derailment. All damages must be reported immediately to the Railroad Local Representative and to the local Railroad Track Maintenance Representative.
- q. The Applicant and Contractor are required to meet all safety standards as defined by the Railroad, Federal Railroad Administration (FRA), Division of Occupational Safety and Health Administration (OSHA), Local, State and Federal Governments and the State Railroad Regulatory Body.

## 2.6 TRACK, GROUND & SHORING MONITORING:

The Contractor must monitor the track, ground and shoring for movement to ensure proper performance of the shoring system and the safe operation of trains. Record top of rail elevations and track alignment for the duration of the project. After the project is complete additional track and ground monitoring may be required as deemed necessary by the Railroad.

- a. Track & Ground Monitoring requirements: In addition to [Table 2](#):
  - For UPRR, see the [Union Pacific Railroad Guidelines for Track & Ground Monitoring](#).
  - For BNSF, subject to direction of the BNSF project engineer for the project
- ii. Deflection Limits ([Table 2](#)), [Section 3.8k](#), for both track and shoring deflection limits.
  - Displacements exceeding the limits defined in [Table 2](#) must be immediately reported to the Railroad. All work on the project must stop and the Railroad may take any action necessary to ensure safe passage of trains. The Contractor must immediately submit a corrective action plan to the Railroad for review and approval. The Railroad must review and approve the proposed repair procedure. The repair must be inspected by the Railroad before any work on the project can proceed.
- b. Any damage to Railroad property such as track, signal equipment or structure could result in a train derailment. All damage must be reported immediately to the Railroad representative in charge of the project and to the Railroad Track Maintenance Representative.

## 2.7 RAILROAD RIGHT-OF-WAY

- a. The Railroad Right-of-Way accommodates existing tracks, drainage systems, multiple utilities, access roads, Railroad support facilities and space for future track(s).
- b. The proposed project shall not limit existing or future Railroad operating capacity and utility accommodations within the Railroad Right-of-Way.
- c. Limits of Railroad Right-of-Way are to be located by the Applicant and identified on the plans.

## 2.8 CONSTRUCTION AND MAINTENANCE AGREEMENT

- a. Prior to construction on Railroad Right-of-Way, Applicants must have an executed a C & M Agreement with the Railroad.
- b. The C & M agreement shall, at a minimum, include a funding source, cost estimate, insurance and indemnification requirements, method of payment, responsibility for design, construction, ownership, maintenance and future replacement.
- c. The Applicant shall own, maintain and replace the proposed project at no cost to the Railroad and with no interruption to Railroad operations during construction, maintenance and future replacement of the structure.
- d. The Railroad shall, at its own expense, be responsible for ownership and maintenance of ballast and track components only.
- e. The Applicant shall provide, at no cost to the Railroad, traffic control and/or detours to allow occupation of the roadway by the Railroad or its contractor(s) to perform periodic inspections as required.
- f. The Applicant is responsible for performing the work in accordance with the terms specified in the C & M Agreement.

## 2.9 RAILROAD REVIEW PROCESS

- a. How to Communicate with the Railroad
  - i. All design and construction submittals shall be sent to the Railroad Representative who will pass them along for Railroad review.
- b. Railroad Compensation Agreement:
  - i. Prior to any review, the Railroad Local Representative shall receive written notice from the Applicant agreeing to pay all costs associated with the Railroad's (or its consultant's) review of the design plans, construction documents and construction monitoring phase. This is often referred to as the Preliminary Engineering Agreement (PE Agreement).
  - ii. The estimated costs of such PE Agreement shall not be the upper limit of the costs but will provide a guideline for budgeting purposes. Regardless, all actual costs incurred by the Railroad (or its consultants) during the review of design plans, construction documents, and construction monitoring submittals shall be fully recoverable from the Applicant.
- c. Railroad Review Duration
  - i. Review of design submittals and resubmittals by the Railroad (or its consultants) will require a minimum of 4 weeks each individual submission to the Railroad.
  - ii. To expedite the review process of the temporary shoring plans, drawings submitted to the Railroad shall be in accordance with these Guidelines. Otherwise, longer review times shall be expected.
  - iii. To avoid impacting the construction schedule, the Contractor should schedule submittals at least 4 to 6 months in advance.
  - iv. Partial, incomplete or inadequate designs will be rejected, thus delaying the approval.
  - v. Revised submittals will follow the same procedure as the initial submittal until all issues are resolved.

d. Applicant and Engineer of Record Review

- i. Before providing submittals for the Railroad to review, the applicant and or Engineer of Record must first review and approve the submittal for compliance with the project specifications, AREMA Manual, these Guidelines and structural capacity. Exceptions or proposed alternatives, if any, must be clearly communicated and identified for all submittals involved.
- ii. Drawings and calculations must be signed and stamped by a licensed professional engineer familiar with railway loadings and is licensed in the state where the shoring system is intended for use.

e. Construction May Commence Only When:

- i. The Contractor must not begin construction of any component of the shoring system affecting the Railroad Right-of-Way until written Railroad approval has been received.

## 2.10 APPROVAL EXPIRATION

- a. Written approval of Final Plans will be valid for two years from the date of approval by the Railroad unless otherwise provided in the C&M Agreement. If construction of the approved structure has not begun within this period, the Railroad shall have the right to perform a design review, at the cost of the Applicant, to confirm compliance with the Railroad's then-current Guidelines before a Railroad Right-of-Entry Agreement is issued to begin construction.

# 3. DESIGN

## 3.1 GENERAL DESIGN REQUIREMENTS

- a. Shoring Zones (see Figure 1 below):

- i. All dimensions are measured perpendicular to the centerline of track.
- ii. For ALL excavations within Zone A, shoring plans shall be accompanied by design calculations.
- iii. All shoring within the limits of Zone A must be placed prior to the start of excavation.

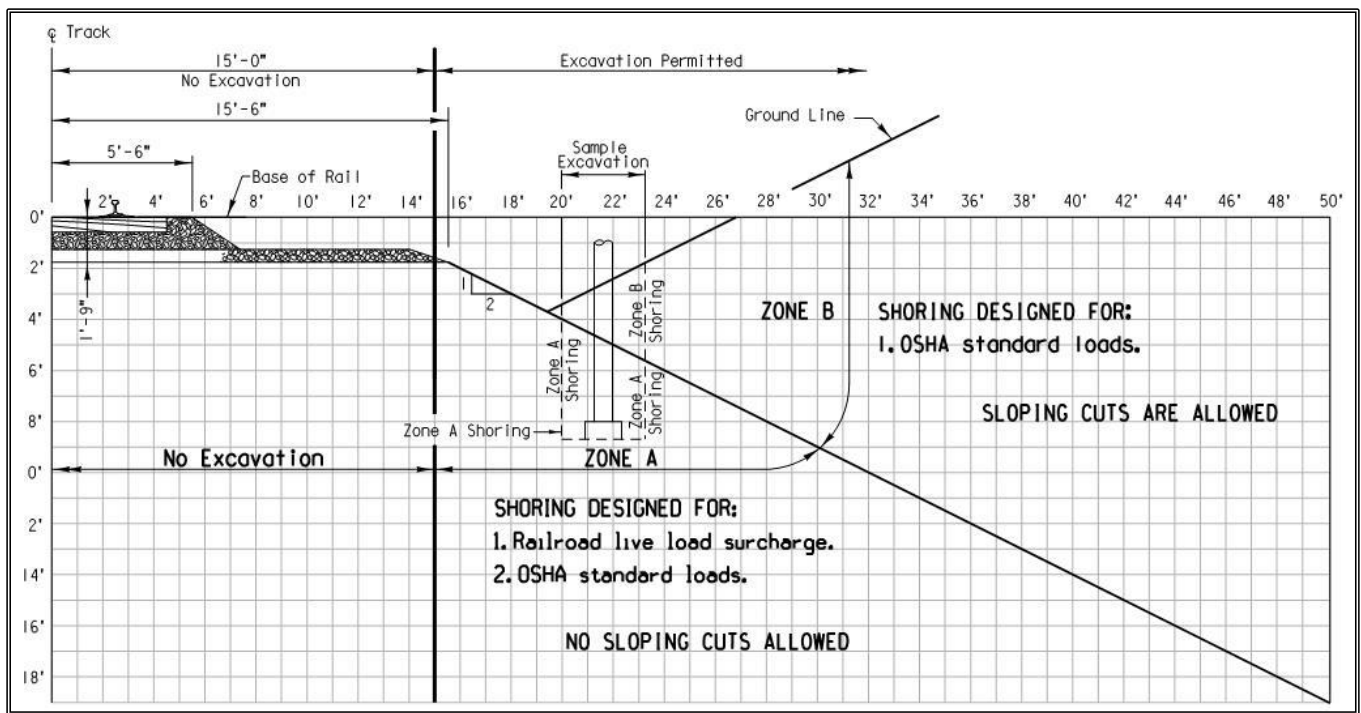

FIGURE 1

- b. Excavation Limits: No excavation shall be permitted closer than 15'-0" measured at a right angle from the centerline of track to the trackside of shoring system.
- c. Evaluate slope and stability conditions to ensure the Railroad embankment will not be adversely affected. Local and global stability conditions must also be evaluated.
- d. Lateral clearances must provide sufficient space for construction of the required Railroad ditches parallel to the standard Railroad roadbed section. The size of ditches will vary depending upon the flow and terrain and should be designed accordingly.
- e. Protect Open Excavations:
  - i. Any excavation, holes or trenches on the Railroad property shall be covered, guarded and/or protected. Handrails, fence, or other barrier methods must meet OSHA and FRA requirements. Temporary lighting may also be required by the Railroad to identify tripping hazards to train crewmen and other Railroad personnel.
- f. The most stringent project specifications shall be used of the Public Utilities Commission Orders, Department of Industrial Safety, OSHA, FRA, AREMA, BNSF, UPRR or other governmental agencies.
- g. Secondhand material is not acceptable unless the Engineer of Record submits a full inspection report which verifies the material properties and condition of the secondhand material. The report must be signed and sealed by the Engineer of Record.
- h. Shoring Removal:
  - i. All components of the shoring system are to be removed when the shoring is no longer needed to the extent that there is no impact to Railroad operations. All voids must be filled and compacted properly, and drainage facilities restored. See compaction requirements in [Section 3.5c](#).
  - ii. If the shoring cannot be completely removed, it shall be removed at least 3.0 feet below the final finished grade or at least 3.0 feet below the base of rail, whichever is lower, unless otherwise specified by the Railroad and only if approved by the Railroad.
  - iii. No traffic during unsupported excavations resulting from shoring removal.
- i. Soldier piles may be installed in predrilled holes if the requirements of [AREMA, Vol. 2, Ch. 8, Article 28.5.4.3](#) and the following are met:
  - i. Slurry and drilling fluid type materials are not acceptable as backfill for soldier piles in drilled holes.
  - ii. Concrete and flowable backfill may be used but might prevent removal of the embedded piles. If width of the drilled hole will be relied on for passive resistance, the concrete backfill shall have a minimum compressive strength of 3,000 psi, and a minimum coverage of at least 3.0 inches between the edge of the pile and drilled hole.
  - iii. Compacted pea gravel material is allowed as backfill if the groundwater level is below the bottom of the drilled hole, the diameter of the hole is at least 12 inches greater than the diagonal width of the pile, and the pea gravel is placed in successive lifts of 8 inches or less in thickness and either consolidated by vibrating the pile or being dry rodded between each lift. The design passive resistance shall be based on the lesser of that derived from either the surrounding subsurface soils or the pea gravel. The pea gravel shall be assumed to have a friction angle no greater than 34 degrees.
  - iv. Temporary or permanent casing is used to support the sides of the drilled hole for holes drilled within 25 feet from centerline of track, or 2 times the hole diameter plus 15 feet from centerline of track, whichever is greater. The thickness and strength of the steel casing shall be sufficient to support the loads described in [Section 3.7](#), and shall be specified on the plans.
- j. Tieback & Soil Nail Anchor Rods
  - i. Soil Nails are defined as drilled-in ground anchors that require ground and wall movement to occur before fully utilized, and Tiebacks are defined as tie rods and drilled-in ground anchors that are prestressed after installation.



- ii. Tiebacks & Soil Nails are not approved to permanently retain Railroad embankment supporting tracks.
  - iii. Tiebacks & Soil Nails installed below active tracks shall be cased during anchor installation.
  - iv. Tiebacks & Soil Nails shall be installed a minimum of 6 feet below base of rail, unless comprised of fiberglass or fully removed after the shoring is no longer needed. Additionally, the upper surface of the grouted tieback or soil nail shall be no less than 3.5 feet below base of rail.
  - v. Tiebacks & Soil Nails shall be designed for gravity placement of grout unless pressure grouting can be proven to not cause an unacceptable risk of track heave.
  - vi. For shoring that will extend above existing grade, which will result in the shoring being backfilled with compacted fill, settlement of the backfill, and associated impacts to shoring and adjacent structures, shall be evaluated. If tieback tie rods will be installed within the compacted backfill, the tie rods shall be placed in the bottom of pipe sleeves that have sufficient diameter to prevent vertical loading on the tie rods from backfill settlement. The pipe sleeves shall also have sufficient strength to support overburden backfill and surcharge loads.
  - vii. The contractor is responsible for providing an approved test method to verify the capacity of anchored or tieback systems. The manufacturers recommendations for testing must be satisfied. Systems which support the Railroad embankment will be considered high risk in determining the percentage of elements to be proof tested.
  - viii. Cement-grouted anchors tiebacks shall be installed, tested and stressed in accordance with the project specifications, AREMA requirements, FHWA-IF-99-015, Geotechnical Engineering Circular 4, Ground Anchors and Anchored Systems.
- k. The proximity of existing structures shall be evaluated when determining shoring installation methods. Installation of shoring by vibratory or impact hammers has the potential to cause dynamically induced subsidence of existing structures and track. The Railroad may dictate shoring installation methods as required on a case by case basis.

### 3.2 INFORMATION REQUIRED

- a. Plans and calculations shall be submitted, signed and stamped by a Licensed Professional Engineer familiar with Railroad loadings and who is licensed in the state where the shoring system is intended for use. See [Section 3.9](#) for requirements on plan submittals. In addition to plans and calculations, the following information is also required.
- b. Field Survey
  - i. The field survey shall be referenced to the centerline of track(s) and top of rail elevations. Existing grades and alignment of tracks and roads shall be surveyed. The location of existing utilities shall also be determined.
- c. Drainage
  - i. The drainage pattern of the site before and after construction should be analyzed and adequate drainage provisions should be incorporated into the plans and specifications. Consideration should be given to groundwater seepage as well as surface drainage.
  - ii. Drainage provisions for backfill should be compatible with the assumed water conditions in design.
- d. Geotechnical Report – See [Section 3.5](#), Subsurface Characterization.
- e. Assumed Loading – See [Section 3.7](#), Applied Loads and Calculations.
- f. Structural Design Calculations – See [Section 3.8](#), Structural Design Calculations.

### 3.3 DESIGN PROCEDURE

a. Shoring design should generally adhere to the following procedure:

**Step 1)** Determine proposed excavation location and depth.

**Step 2)** Establish subsurface and surface conditions at proposed shoring location. See [Section 3.5](#) for requirements.

**Step 3)** Select shoring type (see [Section 3.6](#))

**Step 4)** Determine Applied Loads

- Lateral Driving Pressures on back side of shoring, which would consist of the following:
  - Earth pressure (Active, At-Rest, Apparent) (see [Sections 3.7c.i, 3.7c.ii, and 3.7c.iii](#))
  - Surcharge pressures (see [Section 3.7c.iv](#))
  - Hydrostatic pressure (see [Section 3.7c.v](#))
- Lateral Resisting Pressures on the front side of shoring, which would consist of the following:
  - Passive earth pressure (see [Section 3.7d.i](#)).
  - Passive earth pressure reductions (e.g., seepage uplift) (see [Section 3.7d.ii](#))
  - Resisting loads from braces and tiebacks

**Step 5)** Perform Structural Design Calculations

- Perform stability analysis to establish the minimum embedment depth of shoring and anchor/brace loads (see [Section 3.8j](#)).
  - For complex shoring designs, perform global and basal heave stability analyses (see [Section 3.8j](#)).
- Verify deflection is within that allowable (see [Section 3.8k](#)).
- Verify strength of structural elements are not exceeded (see [Section 3.8i](#))

### 3.4 (Step 1) EXCAVATION LOCATION

a. See [Figure 1, Section 3.1b](#) for excavation limits.

b. Shoring systems should be located as far from the Railroad track and structures as possible.

### 3.5 (Step 2) SUBSURFACE CHARACTERIZATION

a. Subsurface exploration.

- i. Sufficient borings shall be made along the length of the structure to determine, with a reasonable degree of certainty, the subsurface conditions. Irregularities found during the initial soil boring program may dictate that additional borings be performed.
- ii. In general, borings should be performed within 50 feet of the planned location of shoring, or closer as necessary. If the planned shoring is longer than 250 feet in length, additional borings shall be performed along the length of the shoring on an average spacing of 250 feet.
- iii. Borings shall be performed to a depth sufficient to fully characterize the soils adjacent to and below the proposed shoring.
- iv. Unless otherwise stated in these guidelines, subsurface investigation shall also be made in accordance with the provisions of [AREMA, Vol. 2, Ch. 8, Part 22](#), Geotechnical Subsurface Investigation.

b. Type of backfill and backfill properties.

- i. Backfill is defined as material behind the wall, whether undisturbed ground or compacted fill, that contributes to the pressure against the wall.

- ii. The compacted fill may be classified with reference to the soil types described in [AREMA Vol. 2, Ch. 8, Articles 5.2.5 and 5.3.2](#). However, the unit weight used in design shall be representative of the actual unit weight of the material as measured by laboratory testing.
- c. Backfill placement and compaction.
  - i. The compacted fill shall meet the latest version requirements of [Section 31 23 26 of the UPRR General Conditions and Specifications \(UPRR\)](#) or BNSF Standard Construction Specifications (BNSF).
  - ii. No dumping of backfill material shall be permitted in such a way that the successive layers slope downward toward the wall. The layers shall be horizontal or shall slope downward away from the wall.
  - iii. If the wall is not free to rotate (i.e., is anchored or braced) and achieve an active condition during compaction of the backfill, the induced earth pressure due to compaction shall be evaluated. The assumed earth pressure shall be no less than the at-rest earth pressure (see [Section 3.7c.ii](#)).
- d. Stress states and corresponding soil strength properties.
  - i. Saturated cohesive soils (clays and some silts) can reside in two different stress states while shoring is in service:
    - Undrained / Total Stress: A short-term condition where the undrained shear strength ( $S_u$ ) of the soil should be used for analysis.
    - Drained / Effective Stress: A long-term condition where drained effective friction angle ( $\phi'$ ) and effective cohesion ( $c'$ ) of the soil should be used for analysis.
  - ii. It is impossible to accurately predict how long saturated cohesive soils will remain in an undrained / total stress state before pore pressures dissipate and the soil achieves a drained / effective stress state. For this reason, the Undrained Cohesive soil state shall only control for design when it results in a higher factor of safety for the shoring design than that estimated for the Drained Cohesive soil state. This will generally only be the case when the cohesive soils are relatively soft.
  - iii. It is noted that cohesive soils can also reside in an “unsaturated” state, where the soil can be characterized by an unsaturated shear strength. The unsaturated shear strength of a cohesive soil can vary drastically as it’s moisture content increases or decreases. Given the impossibility of predicting moisture content changes for soils exposed to weather and groundwater fluctuations, the unsaturated shear strength of the soil shall not be used for design.
  - iv. Saturated and unsaturated cohesionless soils (some silts, sands, and gravels) should be assumed to always reside in a drained / effective stress state.
- e. A Geotechnical Report summarizing the existing and proposed subsurface conditions shall be provided by a Licensed Professional Engineer. The Geotechnical Report shall include:
  - i. Boring location plan showing the location of each boring in relation to tracks and the proposed shoring.
  - ii. Boring logs that indicate the elevation and depth of each layer of soil encountered, USCS classification of each layer of soil, an indication of whether the soil is fill or natural soil, the depth/elevation of groundwater, results of in-situ testing, index properties of the soil layers as determined by laboratory testing (e.g., moisture, density, sand content, plasticity, unconfined strength, etc.)
  - iii. Results of all laboratory testing. Laboratory testing shall include at a minimum: moisture content, density, unconfined compression tests on clay/rock, and direct shear or triaxial compression testing on soils to determine the effective cohesion and internal angle of friction.

- iv. Recommended soil properties for the design of shoring for each layer of soil as follows:
  - Top/bottom elevation of soil layer
  - Moist ( $\gamma$ ) and effective ( $\gamma'$ ) unit weight
  - Undrained shear strength ( $S_u$ ) of cohesive soils
  - Effective cohesion ( $c'$ ) and friction angle ( $\phi'$ )
  - Active and passive earth pressure coefficients
  - Parameters for p-y curve generation, if necessary.
- v. If required, allowable bearing capacity for spread footings.
- vi. Compaction recommendations for backfill, optimum moisture content and maximum density of fill material, and design parameters for the compacted fill. See [Sections 3.5b and 3.5c](#).
- vii. Water table elevation to be assumed on both sides of the shoring system.
- viii. Dewatering recommendations, as needed, and proposed flownets or zones of groundwater influence.

### 3.6 (Step 3) SHORING TYPES

- a. Shoring/Trench Box is a prefabricated shoring system which is installed as the excavation progresses. This system is allowed in special applications only, typically where Railroad live load surcharge is not present unless it can be shown that the over excavation outside the box will be filled and compacted before the presence of Railroad live load.
- b. Anchored systems with tiebacks are discouraged, as the tiebacks will be an obstruction to future utility installations and may also damage existing utilities. If used, see Section 3.1.j for design requirements for tiebacks and soil nails.
- c. Sheet Pile Wall (Anchored) is a structure designed to provide lateral support for a soil mass and derives stability from passive resistance of the soil in which the sheet pile is embedded and the tensile resistance of tiebacks.
- d. Sheet Pile Wall (Cantilevered) is a structure designed to provide lateral support for a soil mass and derives stability from passive resistance of the soil in which the sheet pile is embedded. Cantilever sheet pile walls shall be used only in granular soils or stiff clays. The maximum height of wall above the excavation line shall be 10 feet in Zone A (see [Figure 1](#)) and 12 feet in Zone B.
- e. Soldier Pile with Lagging Wall (Anchored) is a structure designed to provide lateral support for a soil mass and derives stability from passive resistance of the soil/rock in which the soldier beam is embedded and from the tensile resistance of tiebacks. Soldier beams include steel H-piles, wide flange sections or other fabricated sections that are driven or set in drilled holes. Lagging refers to the members spanning between soldier beams.
- f. Soldier Pile with Lagging Wall (Cantilever) is a structure designed to provide lateral support for a soil mass and derives stability from passive resistance of the soil/rock in which the soldier beam is embedded. The maximum height of the wall above the excavation line shall be 8 feet for Zone A (see [Figure 1](#)) and 12 feet for Zone B.
- g. Braced Excavation is a structure designed to provide lateral support for a soil mass and derives stability from passive resistance of the soil in which the vertical members are embedded and from the structural capacity of the bracing members. For purposes of these guidelines, the vertical members of the braced excavation system include steel sheet piling or soldier beams comprised of steel H-piles, wide flange sections, or other fabricated sections that are driven or installed in drilled holes. Wales are horizontal structural members designed to transfer lateral loads from the vertical members to struts or rakers. Struts and rakers are structural compression members that support the lateral loads from the wales and transfer the load to either another side of a shored excavation (struts) or to a reaction pile/thrust block (raker).
- h. Cofferdam is an enclosed temporary structure used to keep water and soil out of an excavation for a permanent structure such as a bridge pier or abutment or similar structure. Cofferdams may be

constructed of timber, steel, concrete or a combination of these. These guidelines consider cofferdams primarily constructed with steel sheet piles.

### 3.7 (Step 4) APPLIED LOADS AND CALCULATIONS

- a. For shoring design submittal, all design criteria, temporary and permanent loading must be clearly stated in the design calculations and on the contract and record plans.
- b. Applied loading will consist of driving pressures/forces on the back of the shoring and resisting pressures/forces on the front of the shoring.
  - Driving pressure will generally consist of:
    - Active, At-Rest & Apparent pressures. ([Sections 3.7c.i, 3.7c.ii, 3.7c.iii](#))
    - Surcharge ([Section 3.7c.iv](#))
    - Hydrostatic pressures ([Section 3.7c.v](#)).
  - Resisting pressure will generally consist of:
    - Passive earth pressure (3.7d.i) and brace/tieback loading.
- c. **Driving Pressures/Loads:**
  - i. **Active Earth Pressure**
    - Use for cantilever walls and flexible walls with only one row of tiebacks/braces (i.e., flexible anchored bulkheads), if the minimum deflection criteria per AREMA Vol. 2, Ch. 8, Article 20.1.2.d is met. If the minimum deflection criteria for flexible anchored bulkheads is not met, use Apparent Earth Pressure for top-down shoring construction ([Section 3.7c.iii](#)), and At-Rest Earth Pressure for walls that are backfilled ([Section 3.7c.ii](#)).
    - The active earth pressure may be computed by the Rankine, Coulomb or Log-Spiral theories. The active earth pressure may also be based on general soil type per [AREMA Vol. 2, Ch. 8, Part 20, Table 8-20-3](#) as provided in the [Appendix](#).
    - For interface friction angles used for Coulomb and Log-Spiral theories, the interface friction angle shall not be greater than one-half of the effective friction angle of the soil, or that consistent with published values for specific types of soil in contact with either steel or concrete (e.g., **NAVFAC DM7.02, Chapter 3, Table 1**).
    - The backslope of the retained soil shall be considered when calculating the active earth pressure.
    - See [Section 3.5b](#). Subsurface Characterization, for further requirements for computing earth pressure from compacted backfill.

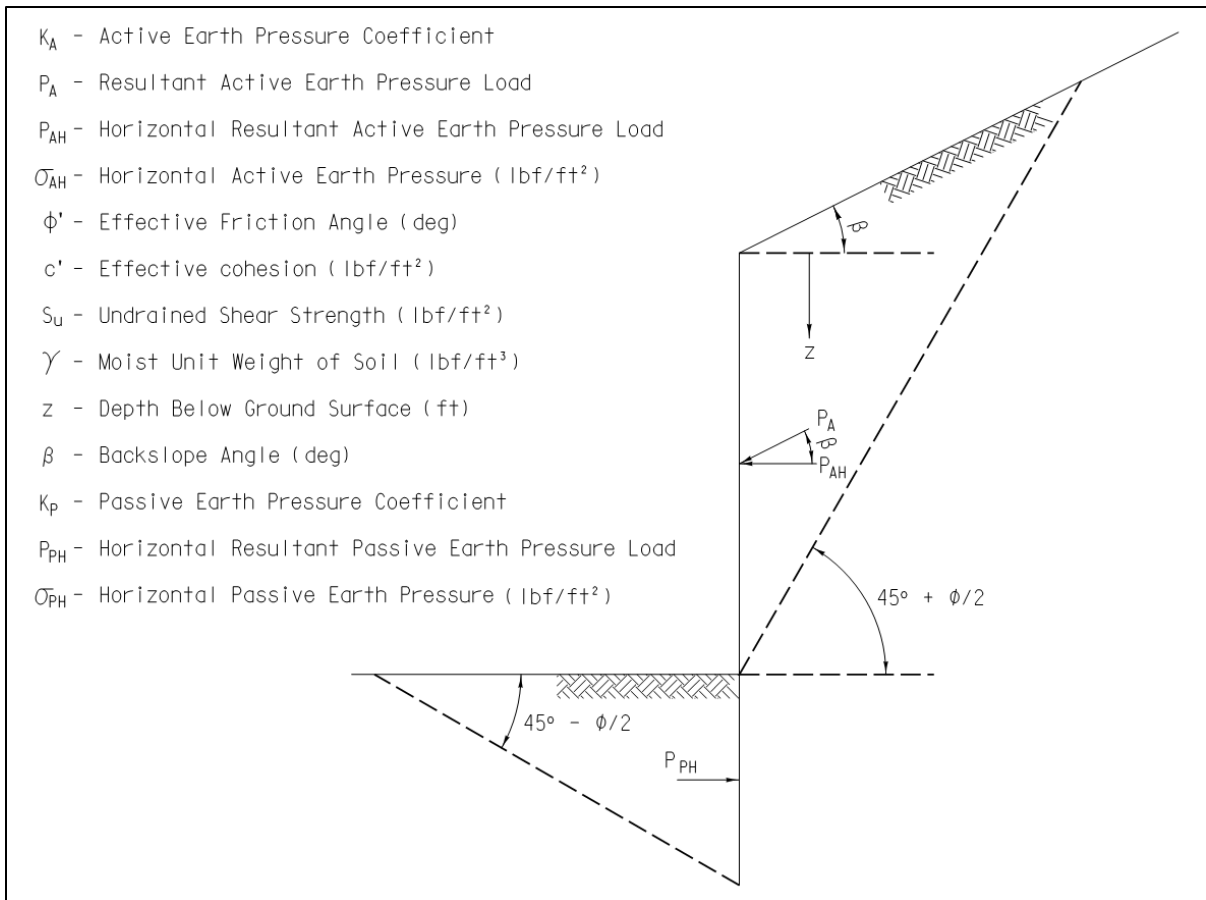

**FIGURE 2**

❖ **NON-COHESIVE SOILS**

Level Backslope (Rankine)

$$\sigma_{AH} = K_A \gamma z, \text{ where } K_A = \tan^2 \left( 45 - \frac{\phi'}{2} \right)$$

Sloping Backslope (Rankine)

$$\sigma_{AH} = K_A \gamma z \cos \beta, \text{ where } K_A = \cos \beta \left( \frac{\cos \beta - \sqrt{\cos^2 \beta - \cos^2 \phi'}}{\cos \beta + \sqrt{\cos^2 \beta - \cos^2 \phi'}} \right)$$

❖ **COHESIVE SOILS & FRACTURED ROCK**

Drained Cohesive & Fractured Rock - Level & Sloping Backslope (Rankine/Bell)

- Use these drained equations unless the undrained equations below result in greater earth pressures in the shoring design.

$$\sigma_{AH} = K_A \gamma z - 2c' \sqrt{K_A}$$

$$K_A = \tan^2 \left( 45 - \frac{\phi'}{2} \right), \text{ For Level Backslope}$$

$$K_A = \cos \beta \left( \frac{\cos \beta - \sqrt{\cos^2 \beta - \cos^2 \phi'}}{\cos \beta + \sqrt{\cos^2 \beta - \cos^2 \phi'}} \right), \text{ For Sloping Backslope}$$

- **Effective Cohesion Note:** Effective cohesion shall be assumed to be zero, unless local experience by a Licensed Geotechnical Engineer indicates the fully softened strength of the clay will have an effective cohesion greater than zero.
- **Fractured Rock Note:** The active earth pressure for fractured rock and intermediate geomaterials (e.g., weak shales, sandstone, etc.) shall be based on either the rock mass effective cohesion and friction angle, or mass shear strength. The mass strength parameters shall be determined using a methodology that accounts for rock type, intact strength, spacing and conditions of joints, rock quality designation (RQD), geological strength index (GSI), and/or rock mass rating (RMR).

#### Undrained Cohesive – Level Ground (Rankine/Bell)

- Only use undrained when it results in a higher earth pressure in the shoring design. Otherwise use the Drained equations above.
- Assumes  $\phi=0$  and  $c'=S_u$

$$\sigma_{AH} = \gamma z - 2S_u$$

**or**

$$\sigma_{AH} = K_A \gamma z, \text{ where } K_A = 1 - \frac{2S_u}{\gamma z}$$

#### Very Soft to Medium Clays/Silts

- Where the Stability Number  $N_s = \gamma H / S_{ub}$  is greater than 4, active earth pressure shall be estimated as the greater of that determined using the equations above for drained (effective) and undrained (total stress) conditions, or the equations directly below. The factor of safety against basal heave shall also be analyzed per [Section 3.8j.ii3.8](#). For  $N_s > 6$ , the global stability of the shoring shall also be evaluated by a limit-equilibrium method of slices per [Section 3.8j.ii](#).

- For  $4 < N_s < 5.14$ ,  $K_A = 0.22$
- For  $N_s > 5.14$  (Henkel, 1971),  $K_A = 1 - \frac{4S_u}{\gamma H} + 2\sqrt{2} \frac{d}{H} \left(1 - \frac{5.14S_{ub}}{\gamma H}\right) \geq 0.22$

Where:

$S_u$  = Undrained strength of retained soil (lbf/ft<sup>2</sup>)

$S_{ub}$  = Undrained strength of soil below excavation base (lbf/ft<sup>2</sup>)

$\gamma$  = Total unit weight of retained soil (lbf/ft<sup>3</sup>)

H = Total excavation depth (ft)

d = Depth of potential base failure surface below base of excavation (ft)

(The lessor of either the thickness of soft to medium stiff clay below the bottom of excavation, or the width of the excavation divided by the square root of 2. See [Figure 3](#) below.)

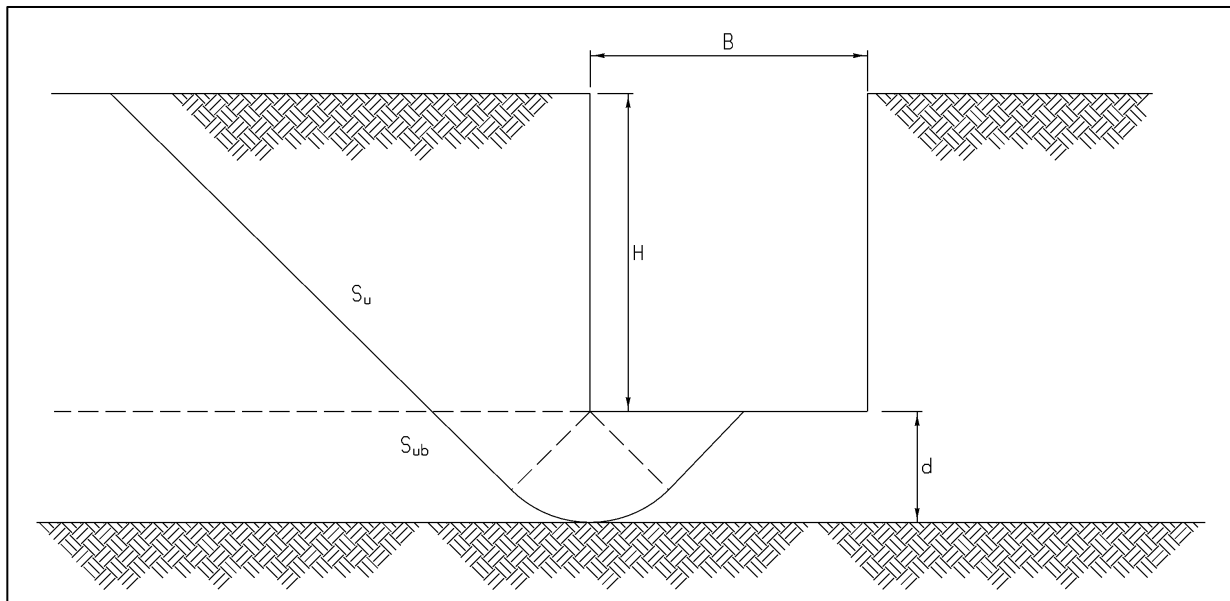

**FIGURE 3**

**ii. At-Rest Earth Pressure.**

- Used for rigid walls (e.g., reinforced concrete walls) that deflect less than that indicated in [Table 1](#).

**Table 1 - When to Use At-Rest Earth Pressure**

Type of Backfill	Wall Deflection / Wall Height
Dense sand	0.001
Medium dense sand	0.002
Loose sand	0.004
Compacted Silt	0.002
Compacted lean clay	0.010
Compacted fat clay	0.010

(Clough & Duncan, 1991)

- At-Rest earth pressure shall also be used for walls that are restrained above the dredge line by braces/tiebacks and are backfilled with compacted fill. See also [Section 3.8j.ii](#).
- At-Rest earth pressure shall be calculated as follows:

Level Ground

$$\sigma_{0H} = K_0 \gamma z , \text{ where } K_0 = (1 - \sin\phi')OCR^{(\sin\phi')}$$

Sloping Backslope

$$\sigma_{0H} = K_0 \gamma z (1 + \sin\beta)$$

Where:

- $\sigma_{0H}$  – Horizontal At-Rest Earth Pressure (lbf/ft<sup>2</sup>)
- $K_0$  – At-Rest Earth Pressure Coefficient
- $\phi'$  – Effective Friction Angle (deg)
- OCR – Over-Consolidation Ratio
- $\beta$  – Backslope Angle (deg)



### iii. Apparent Earth Pressure

- Use for braced excavations with single or multiple levels of braces/tiebacks.
- Use equations determined per [AREMA Vol. 2, Ch. 8, Article 28.5.4.1](#) or [FHWA-IF-99-015, Sections 5.2.4](#) (sands), [5.2.5](#) (stiff to hard clays) and [5.2.6](#) (soft to medium clays).
- For braced excavations that bottom out in very soft to medium stiff clays/silts, where the Stability Number  $N_s = \gamma \cdot H / S_{ub}$  is greater than 4, the requirements of [Section 3.7c.i](#) for very soft to medium clays shall also apply if they control for design.

### iv. Surcharge Loads

- Loads include but are not limited to: Railroad vertical and centrifugal loading, railroad service vehicles (HS-20 truck), roadway loading, fills placed above the top of shoring, construction equipment, crane pads, future grading and paving, structures, material storage piles, and snow.
- Dead load assumptions to be used for design:
  - Spoil pile: must be included assuming a minimum height of two feet of soil adjacent to the excavation.
  - Track: use 200 lbs/linear-ft for rails, inside guardrails and fasteners.
  - Roadbed: ballast, including track ties, use 120 lbs per cubic foot.
- For specific applications of the Cooper E80 live load, refer to in [Appendix 5.1](#), which illustrates Live Load Pressure Due to Cooper E80.
- Additional analysis for centrifugal force calculations as described in [AREMA Vol. 2, Ch. 15, Article 1.3.6](#). Centrifugal Loads are required where shoring is located along the outer side of curved track and track curvature exceeds three degrees.
- Lateral pressure from to infinite and uniform surcharge load.
  - The surcharge can effectively be treated as another soil layer, whereby the vertical surcharge pressure is multiplied by the active or at-rest earth pressure coefficient as shown below:

$$\sigma_{UA} = K_A q \quad \text{or} \quad \sigma_{U0} = K_0 q$$

Where:

$\sigma_{UA}$  – Uniform lateral surcharge pressure for active condition (lbf/ft<sup>2</sup>)

$\sigma_{U0}$  – Uniform lateral surcharge pressure for at-rest condition (lbf/ft<sup>2</sup>)

$K_A$  - Active earth pressure coefficient

$K_0$  – At-rest earth pressure coefficient

q - Uniform surcharge load (lbf/ft<sup>2</sup>)

- Lateral pressure from to point, line, uniform strip, and rectangular-area surcharge loads.
  - Equations shall be based on Boussinesq theory (i.e., elastic theory) and a rigid wall condition.
  - For point loads, see **AREMA, Vol. 2 , Ch. 8, Article 20.3.2.4**.
  - For line loads, see **AREMA, Vol. 2 , Ch. 8, Article 20.3.2.3**.
  - For rectangular loads, see **NAVFAC DM7.02, Figure 11**.
  - For uniform strip loads, see Case I (Cooper E80 loading parallel to walls) in [Appendix 5.1](#), or **AREMA, Vol. 2 , Ch. 8, Article 20.3.2.2**.
- Trial Wedge method per [AREMA, Vol. 2 , Ch. 8, Article C5.3.2.II](#) may also be used.

v. **Hydrostatic Pressure Due to Unbalanced Groundwater Levels.**

- Hydrostatic pressure shall be assumed on secant/tangent pile and sheet pile shoring if the base of the excavation extends below the water table and no drainage system is installed behind the shoring.
- Weep holes are not considered an effective drainage system, unless the soil behind the shoring above the dredge line is uniformly free-draining granular material.

d. **Resisting Pressures/Loads:**

i. **Passive earth pressure**

- The passive earth pressure,  $P_p$ , below the excavation line may be computed by Rankine or Log-Spiral theories, but not the Coulomb theory.
- For Log-Spiral theory, the interface friction angle shall not be greater than one-half of the effective friction angle of the soil, or that consistent with published values for specific types of soil in contact with either steel or concrete.
- The passive earth pressure for cohesionless soils (sands, gravels and some silts), uncontrolled fill, and mixed layers of cohesive and cohesionless soil shall be calculated based on the effective friction angle of the soil.
- The passive earth pressure for cohesive (clay and some silts) soils and controlled backfill shall be calculated for the effective stress condition (see [Section 3.5d.i](#) for definition), unless the resulting earth pressure for the total stress condition (i.e.,  $S_u$ ) is less.
- For conditions where the slope in front of the shoring slopes down and away from the wall, the slope in front of the wall shall be considered when calculating passive pressure. If the ground in front of the shoring slopes upwards away from the wall, the ground level shall be assumed to be level for analysis.
- For reference, Rankine equations are provided below:

$K_P$  – Passive Earth Pressure Coefficient

$\sigma_{PH}$  – Horizontal Passive Earth Pressure (lbf/ft<sup>2</sup>)

$\phi'$  – Effective Friction Angle (deg)

$c'$  – Effective cohesion (lbf/ft<sup>2</sup>)

$S_u$  – Undrained Shear Strength (lbf/ft<sup>2</sup>)

$\gamma$  – Moist Unit Weight of Soil (lbf/ft<sup>3</sup>)

$z$  – Depth Below Ground Surface (ft)

$\beta$  – Front Slope Angle (deg)

NON-COHESIVE SOILS

Level Frontslope (Rankine)

$$\sigma_{PH} = K_P \gamma z, \text{ where } K_P = \tan^2 \left( 45 + \frac{\phi'}{2} \right)$$

Sloping Frontslope (Rankine)

- Use only if ground is sloping down and away from shoring (i.e.,  $\beta$  is negative)

$$\sigma_{PH} = K_P \gamma z \cos \beta, \text{ where } K_P = \cos \beta \left( \frac{\cos \beta + \sqrt{\cos^2 \beta - \cos^2 \phi'}}{\cos \beta - \sqrt{\cos^2 \beta - \cos^2 \phi'}} \right)$$

## COHESIVE SOILS & FRACTURED ROCK

### Drained Cohesive & Fractured Rock - Level & Sloping Backslope (Bell's)

$$\sigma_{PH} = K_P \gamma z + 2c' \sqrt{K_P}$$

$$K_P = \tan^2 \left( 45 + \frac{\phi'}{2} \right), \text{ For Level Frontslope}$$

$$K_P = \cos\beta \left( \frac{\cos\beta + \sqrt{\cos^2\beta - \cos^2\phi'}}{\cos\beta - \sqrt{\cos^2\beta - \cos^2\phi'}} \right), \text{ For Sloping Frontslope}$$

- Effective cohesion shall be assumed to be zero unless local experience by a Licensed Geotechnical Engineer indicates the fully softened strength of the clay will have an effective cohesion greater than zero.
- The passive resistance for fractured rock and intermediate geomaterials (e.g., weak shales, sandstone, etc.) shall be based on either the rock mass effective cohesion and friction angle, or mass shear strength. The mass strength parameters shall be determined using a methodology that accounts for rock type, intact strength, spacing and conditions of joints, rock quality designation (RQD), geological strength index (GSI), and/or rock mass rating (RMR).

### Undrained Cohesive – Level Ground (Rankine/Bell)

- Only use undrained when it results in a lower earth pressure in the shoring design. Otherwise use Drained equations above.
- Assumes  $\phi=0$  and  $c'=S_u$

$$\sigma_{PH} = \gamma z + 2S_u$$

**or**

$$\sigma_{PH} = K_P \gamma z \text{ where } K_P = 1 + \frac{2S_u}{\gamma z}$$

- For soldier pile walls, the upper 1.5 pile/shaft diameters of passive resistance in soil below the excavation line shall be ignored per [AREMA, Vol. 2, Ch. 8, Article 28.5.3.2.a](#).
  - Allowable arching factors for soldier pile walls shall comply with [AREMA, Vol. 2, Ch. 8, Article 28.5.3.2.a](#).
  - As noted in [Section 3.1i.ii](#) above, the width of the drilled hole for a soldier pile shall not be assumed to provide passive resistance unless the concrete backfill has a minimum compressive strength of 3,000 psi, and a minimum coverage of at least 3.0 inches between the edge of the pile and drilled hole.
  - P-y curve methods shall use a P-multiplier less than 1 to account for group effects on sheet and soldier pile walls when piles are spaced less than 3.5D apart on center, and for slopes in front of the wall.
- ii. Seepage pressures on bulkheads and cofferdams.
- Where the imbalance of water levels results in water seeping under the bottom of shoring and upward into the excavation, the seepage pressures on the wall and base of excavation shall be based on flownet or equivalent analyses, and the passive resistance reduced accordingly. See [AREMA, Vol. 2, Ch. 8, Article 20.3.5](#) or FHWA-IF-99-015 Section 5.2.9 for further detail.

### 3.8 (Step 5) STRUCTURAL DESIGN CALCULATIONS

- a. Temporary shoring is defined by [AREMA, Vol. 2, Ch. 8, Article 28.1.1](#), and is anticipated to be in service for not more than an 18-month period. Earth retention structures that are anticipated to be in service for more than 18 months shall be designed per AREMA as permanent structures.
- b. Calculations shall be performed for each stage of construction, when one or more rows of braces/tiebacks are being implemented. The calculations shall be performed for each stage of excavation before the braces/tiebacks are installed for that stage.
- c. Calculations shall be performed by one of two methods:
  1. **Classical Method:** A sum of forces and moments analysis whereby driving and resisting pressures are balanced. Driving pressures are applied from the top to the bottom of the back side of the shoring. For braced excavations, Apparent earth pressure will be applied from the top down to the excavation line, and below the excavation line, Active earth pressure will be applied down to the bottom of the shoring on the back side of the shoring. Resisting pressures/forces are applied from the excavation line to the bottom of the front side of the shoring. To achieve an acceptable factor of safety for embedment, the passive resistance will be reduced as required in [Section 3.8j.i](#). It is noted that all AREMA requirements are based on an assumption that the Classical Method will be used for design.
  2. **P-y Method:** A force-deflection analysis (i.e., Winkler beam analysis) whereby the soil below the excavation line on both sides of the shoring is characterized as springs. Driving earth pressures are generally only applied above the excavation line. However, surcharge loads are generally applied to the bottom of the shoring elements. Minimum embedment is based on the base of the shoring reaching fixity as required in [Section 3.8j.i](#).
- d. Calculations shall be in English units. If Metric units are used, all controlling dimensions, elevations, design criteria assumptions, and material stresses shall be expressed in dual units, with English units to be in parentheses.
- e. List all assumptions used to design the temporary shoring system, and provide references for equations, tables, figures, and design criteria obtained from design manuals and guidelines.
- f. Computerized calculations and programs must clearly indicate the input and output data. List all equations used in determining the output.
- g. Example calculations with values must be provided to support computerized output and match the calculated computer result.
- h. Provide a simple free body diagram showing all controlling dimensions and applied loads on the temporary shoring system.
- i. Documents and manufacturer's recommendations which support the design assumptions must be included with the calculations.
- j. **Embedment depth and stability.**
  - i. The minimum depth of embedment is that required to balance driving and resisting pressures/loads.
    - The minimum factor of safety for balancing active and passive pressures shall be 1.5 (See [AREMA, Vol. 2, Ch. 8, Article 20.5.1.a](#)). The factor of safety is achieved by reducing the passive earth pressure resistance by a factor of 0.67. A calculated factor of safety based on shallow penetration into strong soil layer is not acceptable.
    - Note, some commercially available software packages add ~ 30% length to the embedment computed for moment equilibrium in order to achieve force equilibrium. This additional length added by the software is not the required factor of safety noted above. Additional embedment, beyond the 30% added by the software package, is required to achieve the specified factor of safety.

- The minimum embedment for p-y methods shall be based on both the shoring meeting the deflection limit criteria in [Table 2](#) over the full height of the shoring, and a moment reversal (i.e., moment diagram passes through zero twice) being achieved below the excavation line.
- ii. In special circumstances, as indicated in these guidelines, minimum embedment might also be controlled by basal heave or global stability.
- The minimum factor of safety against basal heave shall be 1.5 for temporary structures. See FHWA-IF-99-015, Section 5.8.2 for further details on methodology.
  - The minimum factor of safety for global stability shall be 1.3 when using a limit-equilibrium method of slices. (See AREMA, Vol. 2, Ch. 8, Article 20.4.1.c). The global stability analyses shall consider failure surfaces that pass both below and through non-continuous shoring (e.g., soldier piles) located below the dredge line, as well as both through and behind wall anchors. See FHWA IF-99-015, Section 5.7.3 for further details on methodology.
  - Global stability shall also be analyzed for slopes steeper than 2(H):1(V) that are above, adjacent or below shoring.
- iii. Multiple tiers of shoring should not be used if the active wedge of the lower wall overlies the passive wedge of the upper wall.
- If there is active/passive overlap between tiers of shoring, or the shoring will be supporting an existing retaining wall, the effect of loading of the upper wall/shoring on the lower wall shall be evaluated. This will require estimating the bearing, sliding and/or passive resistance demand of the upper wall, and applying those demands in part or fully to the lower wall. In addition, any loading in front of or behind the upper wall that is not fully supported by the wall, would also need to be applied to the shoring. Lastly, a global stability analysis per [Section 3.8j.ii](#) shall be performed to determine the external stability of the multi-tiered wall/shoring system.

k. **Deflection limits.**

- i. Calculated total deflections of any part of the temporary shoring system and top of rail elevation shall not exceed the criteria outlined in [Table 2](#) Deflection Criteria. Include the accumulated elastic deflection of all of the wall elements (piles, anchors, lagging, walers, strut/raker restraints, etc.), as well as the deflection due to the passive deflection of the resisting soil mass.

**Table 2 - Deflection Criteria**

Horizontal distance from shoring to track C/L measured at a right angle from track	Maximum horizontal movement of shoring system	Maximum acceptable horizontal or vertical movement of rail
15' < S < 18'	3/8"	1/4"
18' < S < 25'	1/2"	1/4"
S > 25'	1% of shoring height above excavation line	-

- ii. Braced excavations should be designed for conditions in which the ground surface on all sides is relatively uniform in elevation. If the ground surface elevation varies significantly from one side of the excavation to the other, the deflection of the higher braced shoring towards the side with lower braced shoring shall be evaluated. This analysis would approximate that required for shoring supported by rakers, where the lower shoring acts as the raker thrust block, such that the passive deflection of the lower shoring is added to the higher shoring deflection and the resulting sum is verified to not exceed the deflection criteria in [Table 2](#).

## I. **Strength design.**

- i. Shall be performed using the Service Load Design method. Allowable Stresses based on AREMA requirements are as follows:
  - Structural Steel Allowable Stress: See [AREMA, Vol. 2, Ch. 15, Section 1.4, Table 15-1-11](#) For common shoring components, generally 0.55 of the yield strength of the steel.
  - Sheet Pile Sections: 2/3 of yield strength for steel. ([AREMA, Vol. 2, Ch. 8, Article 20.5.7](#))
  - Concrete: 1/3 of Compressive strength. ([AREMA, Vol. 2, Ch. 8, Article 20.5.7](#))
  - Anchor Rods: 1/2 of yield strength for steel. ([AREMA, Vol. 2, Ch. 8, Article 20.5.7](#))
- ii. AISC allowances for increasing allowable stress due to temporary loading conditions are not acceptable.
- iii. Structures and structural members shall be designed to have design strengths at all sections at least equal to the required strengths calculated for the loads and forces in such combinations as stipulated in [AREMA, Vol. 2, Ch. 8, Article 2.2.4b](#), which represents various combinations of loads and forces to which a structure may be subjected. Each part of the structure shall be proportioned for the group loads that are applicable, and the maximum design required shall be used.
- iv. In braced excavations, the connections between struts and wales shall be designed to resist both axial demands as well as the vertical demands from the self-weight of the members and any incidental vertical loads applied during construction.
- v. Stiffeners shall be provided at points of bearing concentrated load. (See [AREMA Vol. 2, Ch.15, Article 1.7.7](#)).
- m. Gravity type temporary shoring systems must also be analyzed for settlement, overturning, sliding, bearing capacity per [AREMA, Vol. 2, Ch. 8, Part 5](#), and global stability per the requirements in [Section 3.8j.ii](#).
- n. Anchor blocks and deadman for tiebacks shall be designed for a safety factor of 2.0, where safety factor is derived as the ratio of the net passive resistance (passive earth pressure minus active earth pressure) on the anchor block to the load on tie rod. To utilize the full allowable anchor capacity, the minimum length of the tie rod shall be as shown in [Figure 4](#). If site constraints prevent the minimum length of tie rods from being implemented, the anchor capacity shall be reduced as Indicated in [Figure 4](#). For deriving anchor block capacity where minimum tie rod length is achieved, NAVFAC DM7.02 or CalTrans 2011 may be referenced.
- i. For sheet and soldier pile deadman, p-y methods may be used. The sum of the estimated deflection of the deadman pile and shoring shall be less than that indicated in [Section 3.8k](#).

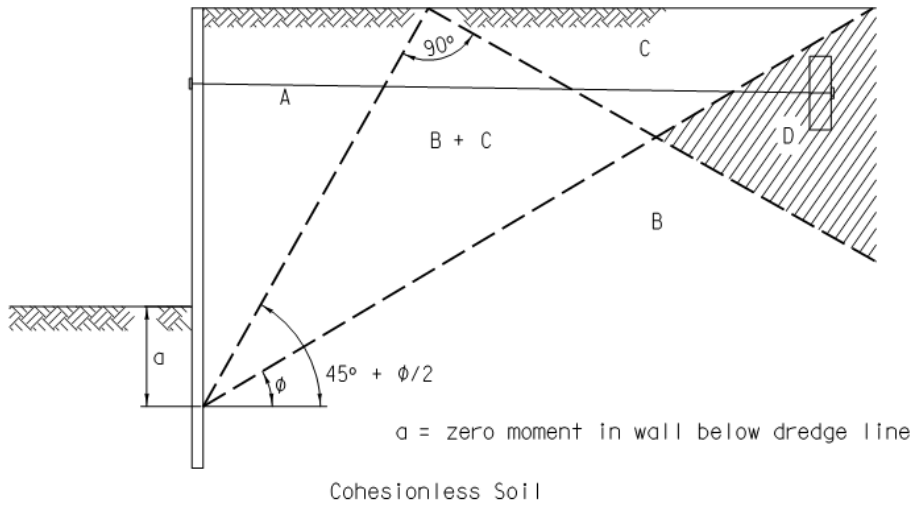

For Cohesionless soils, anchor resistance in each zone is as follows:

A - No Anchor resistance available

B - Anchor block resistance is reduced by  $P'_p - P'_A$

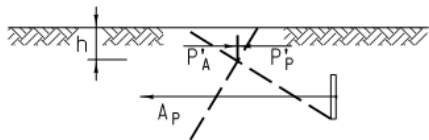

$$P'_p = \frac{1}{2} h^2 \gamma \tan^2 \left( 45^\circ + \frac{\phi}{2} \right)$$

$$P'_A = \frac{1}{2} h^2 \gamma \tan^2 \left( 45^\circ - \frac{\phi}{2} \right)$$

C - Anchor block achieves full resistance but pressure is increased on the wall by  $\Delta P_p$ .  
(See  $\Delta P_p$  force diagram in Theoretical Soil Mechanics, pgs. 232-233 or NAVFAC DM7.02, Figure 20)

B + C - Anchor block resistance is reduced by  $P'_p - P'_A$  and pressure is increased on the wall by  $\Delta P_p$ .

D - Anchor block achieves full resistance without adding additional load to the wall

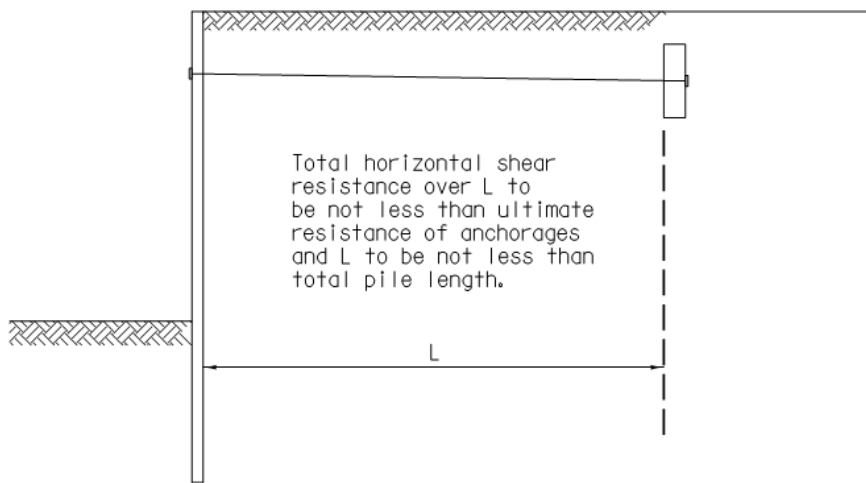

Cohesive Soil or Stratum of Cohesive Extending Below Anchor to Wall (Dismuke, 1991)

**FIGURE 4**

### 3.9 DESIGN PLAN REQUIREMENTS

- a. Shoring design plans shall be in English units. If Metric units are used, all controlling dimensions, elevations, design criteria assumptions, and material stresses shall be expressed in dual units, with English units to be in parentheses. The shoring plans must completely identify the site constraints and the shoring system, and must be signed and stamped by a Licensed Professional Engineer, registered in the state where the work will be performed. Use the design templates provided in the appendix as an example to show the required information, specifications and drawings. The specific requirements of the plan submittals are as follows:

i. **General plan view should show:**

- Railroad Right-of-Way and North arrow.
- Position of all railroad tracks and identify each track as mainline, siding, spur, etc.
- Spacing between all existing tracks.
- Location of all access roadways, drainage ditches and direction of flow.
- Contours of existing grade elevations.
- Footprint of proposed structure, proposed shoring system and any existing structures if applicable.
- Proposed horizontal construction clearances. The minimum allowable is 15 feet measured at a right angle from centerline of track. In curved track the temporary horizontal construction clearances shall increase either 6 inches total or 1.5 inches for every degree of curve, whichever is greater, per [Section 4.4.1.2 of the BNSF-UPRR Guidelines for Railroad Grade Separation Projects](#).
- Location of existing and proposed utilities.
- Location of soil borings used for design.
- Specifications for all elements of the proposed shoring.
- Detailed view of shoring along with controlling elevations and dimensions.

ii. **Typical sections and elevations perpendicular to adjacent track alignment should show:**

- Top of rail and/or top of tie elevations for all tracks.
- Offset from the outside face of shoring system to the centerline of all tracks at all changes in horizontal alignment.
- All structural components, controlling elevations and dimensions of shoring system.
- All drainage ditches and controlling dimensions.
- All slopes, existing structures and other facilities which may surcharge the shoring system.
- Location of all existing and proposed utilities.
- Total depth of shoring system.

- For shoring with tiebacks/bracing, elevations for each temporary stage of shoring construction.
- The assumed groundwater elevation.
- The extent of the Zone A envelope as it overlies the proposed shoring.

iii. **General notes**

- Design loads to be based on the AREMA manual and Cooper E80 loading.
- Pressure due to embankment surcharges.
- ASTM designation and yield strength for each material.
- Maximum allowable bending stress for structural steel is  $0.55F_y$ .
- Temporary overstress allowances are not acceptable.
- All timber members shall be Douglas Fir grade 2 or better.
- In-situ soil classification.
- Backfill soil classification.
- Soil properties used for design.
- Active and passive soil coefficients.
- Fill and backfill compaction criteria.
- Slopes without shoring shall not be steeper than 2 horizontal to 1 vertical.
- Dredge line elevation.
- Shoring deflection to be calculated and meet Railroad requirements.
- Rail, ground and shoring movement monitoring requirements.

iv. **Miscellaneous:**

- Project name, location, GPS coordinates, track owner, railroad line segment, milepost and subdivision in the title block.
- A detailed construction sequence outlining the installation and removal of the temporary shoring system.
- A description of the tieback installation including



- drilling, casing, grouting, stressing information and testing procedures, anchor capacity, type of tendon, anchorage hardware, minimum unbonded lengths, minimum anchor lengths, angle of installation, tieback locations, spacing, and distance below bottom of tie.
- All details for construction of drainage facilities associated with the shoring system shall be clearly indicated.

- Details and descriptions of all shoring system members and connection details.
- Handrail and protective fence details along the excavation.
- Railroad and other “CALL BEFORE YOU DIG” numbers and web sites
- Construction clearance diagram.

## 4. DEFINITIONS

### **Access Road:**

A road used and controlled by the Railroad for maintenance, inspection and repair.

### **Applicant:**

Any party proposing a temporary retaining structure project on Railroad Right-of-Way or other Railroad operating location, regardless of track being active or out of service. Includes all agents working on behalf of the Applicant.

### **AREMA:**

The current edition of the American Railway Engineering and Maintenance-of-Way Association Manual for Railway Engineering.

### **AASHTO:**

The current edition of the American Association of State Highway and Transportation Officials Standard Specifications for Highway Bridges.

### **BNSF:**

Burlington Northern Sante Fe Railway

### **C & M Agreement:**

A Construction and Maintenance Agreement that has been negotiated between the Railroad and the Applicant that addresses all the duties and responsibilities of each party regarding the construction of the proposed grade separation and the maintenance requirements after construction of the said structure.

### **Construction Documents:**

Design plans and calculations, project and/or standard specifications, geotechnical report and drainage report.

### **Construction Window:**

A timeframe in which construction or maintenance can be performed by the Contractor with the required presence of a Flagman.

### **Contractor:**

The individual, partnership, corporation or joint venture and all principals and representatives (including Applicant’s subcontractors) with whom the contract is made by the Applicant for the construction of the Grade Separation Project.

### **Crossover:**

A track connection which allows trains and on-track equipment to cross from one track to another.

### **Engineer-of-Record:**

The licensed Professional Engineer that develops the criteria and concept for the project and is responsible for the preparation of the Plans and Specifications.

**Final Plans:**

100% plans signed & stamped by the Engineer-of-Record.

**Flagman:**

A qualified employee of the Railroad providing protection to and from Railroad operations per Railroad requirements.

**Guidelines:**

Information contained in this document or referenced in AREMA or AASHTO.

**Grade Separation Project:**

A project that includes an Overhead or Underpass Structure that crosses the Railroad Right-of-Way or other Railroad operating location regardless of track status being active or out of service.

**Main Track:**

A principle track, designated by Timetable or special instructions, upon which train movements are generally authorized and controlled by the train dispatcher. Main Track must not be occupied without proper authority.

**Multiple Main Tracks:**

Two or more parallel or adjacent Main Tracks.

**Overhead Structure:**

A Roadway and/or Trail Structure over the Railroad Right-of-Way.

**Railroad Local Representative / Railroad Representative:**

The individual designated by the Railroad as the primary point of contact for the project.

**Railroad:**

Refers to BNSF Railway and/or Union Pacific Railroad.

**Railroad Track Maintenance Representative (UPRR=MTM, BNSF=RDM):**

Railroad representative responsible for maintenance of the track and supporting subgrade.

**Railroad Right-of-Entry Agreement:**

An agreement between the Railroad and an Applicant or a Contractor allowing access to Railroad property.

**Railroad Right-of-Way:**

The limits of property owned, controlled and/or operated upon by the Railroad.

**Shoofly:**

A temporary track built to bypass an obstruction or construction site.

**Siding:**

A track connected to the Main Track used for storing or passing trains.

**Timetable:**

A Railroad publication with instructions on train, engine or equipment movement. It also contains other essential Railroad information.

**Trail:**

A pathway impacting Railroad Right-of-Way or other Railroad operating locations regardless of track status being active or out of service. This includes pedestrian, bicycle, approved motorized recreational equipment and equestrian uses.

**Underpass Structure:**

Railroad Structure over a Roadway and/or Trail.

**UPRR:**

Union Pacific Railroad

**Yard:**

A system of tracks of defined limits, other than main tracks and sidings, for storing and sorting cars and other purposes.

**Yard Limits:**

A portion of main track designated by "yard limit" signs and included in the timetable special instructions or a track bulletin.

**5. APPENDIX**

**5.1 LIVE LOAD PRESSURE DUE TO COOPER E80 LOADING**

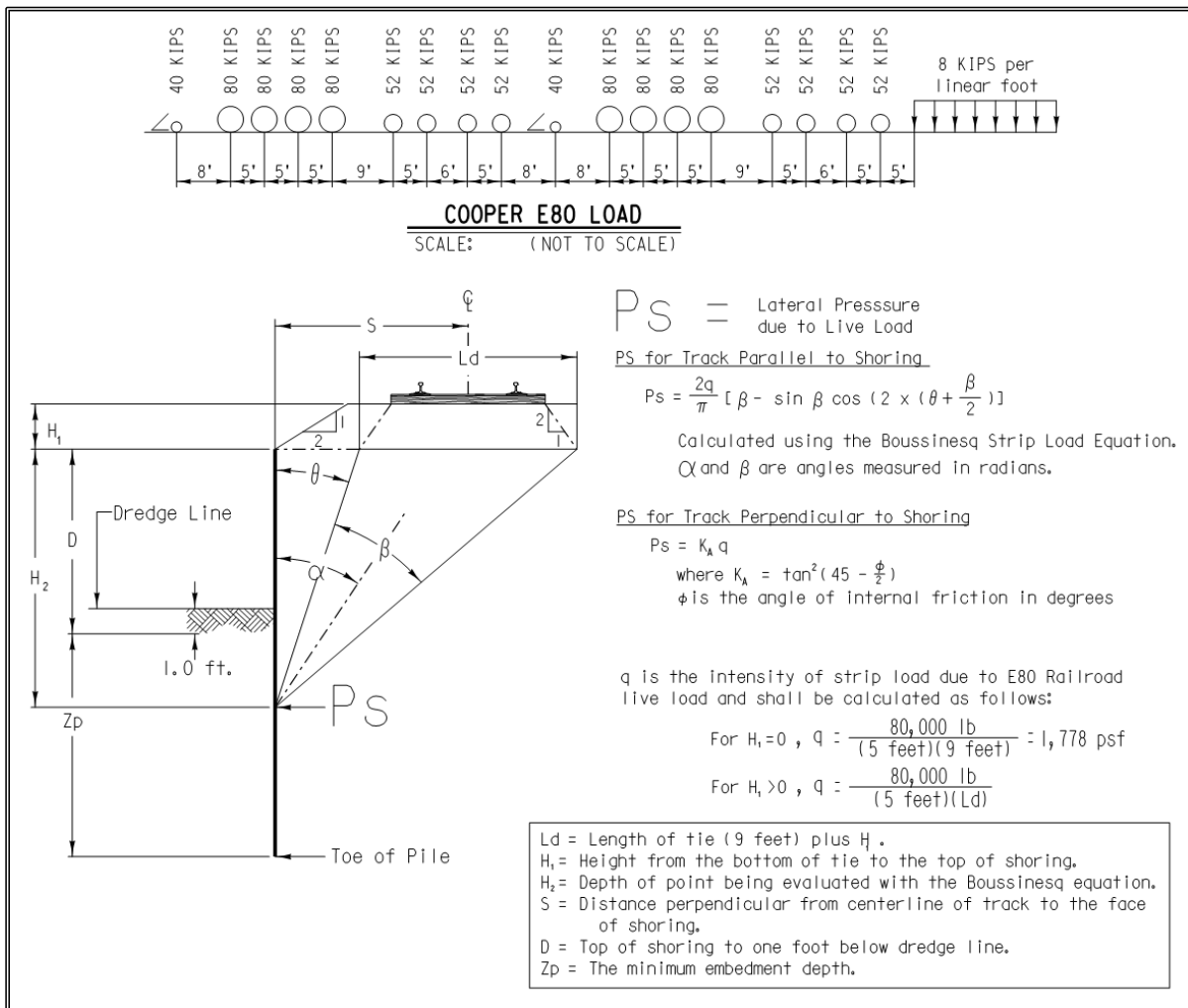

## 5.2 CHART – LIVE LOAD PRESSURE DUE TO E80 LOADING

This chart identifies the active pressure and resulting forces due to E80 liveload.

1. Select distance S from track centerline to face of shoring.
2. Select depth H<sub>2</sub> below base of tie.
3. Read Ps, M, R and  $\bar{z}$  from the table.
4. Use the procedure outlined in the sample problem to determine values at non-tabulated points.

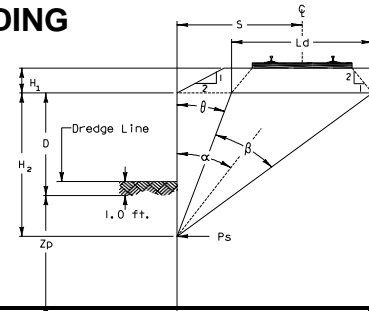

$$P_s = \frac{2q}{\pi} [\beta - \sin \beta \cos(2\alpha)] \quad \text{where } q = 1778 \text{ psf}$$

### Boussinesq surcharge pressure E80 live load for H<sub>1</sub>=0

Depth below top of shoring H <sub>2</sub> (ft)	Variables	Horizontal distance (S) from shoring to track CL measured at a right angle of tie									
		12	14	16	18	20	22	24	26	28	30
2	Ps (psf)	305	220	166	130	105	86	72	61	53	46
	α (radians)	1.38	1.41	1.44	1.45	1.47	1.48	1.48	1.49	1.50	1.50
	β (radians)	0.14	0.10	0.07	0.06	0.05	0.04	0.03	0.03	0.02	0.02
	z (ft)	1.32	1.33	1.33	1.33	1.33	1.33	1.33	1.33	1.33	1.33
	M (ft-lbs/ft)	215	152	114	89	71	58	49	41	36	31
	R (lbs/ft)	317	226	170	132	106	87	73	62	53	46
4	Ps (psf)	496	381	299	240	197	164	138	118	102	89
	α (radians)	1.21	1.27	1.31	1.34	1.36	1.38	1.40	1.41	1.43	1.44
	β (radians)	0.25	0.19	0.14	0.11	0.09	0.07	0.06	0.05	0.05	0.04
	z (ft)	2.59	2.61	2.63	2.64	2.64	2.65	2.65	2.65	2.65	2.66
	M (ft-lbs/ft)	1,609	1,165	882	692	557	459	384	327	281	244
	R (lbs/ft)	1,141	840	643	508	411	339	285	242	209	182
6	Ps (psf)	558	461	381	317	266	225	193	167	146	128
	α (radians)	1.06	1.13	1.19	1.23	1.27	1.29	1.32	1.34	1.35	1.37
	β (radians)	0.33	0.25	0.20	0.16	0.13	0.11	0.09	0.08	0.07	0.06
	z (ft)	3.77	3.83	3.88	3.90	3.92	3.94	3.95	3.96	3.96	3.97
	M (ft-lbs/ft)	4,944	3,674	2,830	2,244	1,822	1,508	1,269	1,082	933	813
	R (lbs/ft)	2,214	1,696	1,332	1,070	877	731	618	529	458	400
8	Ps (psf)	535	476	414	358	309	268	234	205	181	160
	α (radians)	0.94	1.02	1.08	1.13	1.17	1.21	1.24	1.26	1.29	1.30
	β (radians)	0.37	0.29	0.24	0.19	0.16	0.14	0.12	0.10	0.09	0.08
	z (ft)	4.84	4.97	5.06	5.11	5.16	5.19	5.21	5.23	5.24	5.26
	M (ft-lbs/ft)	10,481	8,006	6,286	5,051	4,141	3,452	2,920	2,501	2,165	1,892
	R (lbs/ft)	3,316	2,641	2,134	1,751	1,456	1,228	1,047	903	786	689
10	Ps (psf)	474	449	411	370	329	293	260	232	207	186
	α (radians)	0.83	0.92	0.99	1.04	1.09	1.13	1.17	1.19	1.22	1.24
	β (radians)	0.38	0.32	0.26	0.22	0.19	0.16	0.14	0.12	0.10	0.09
	z (ft)	5.81	6.02	6.16	6.26	6.34	6.39	6.44	6.47	6.50	6.52
	M (ft-lbs/ft)	18,145	14,227	11,385	9,280	7,689	6,463	5,502	4,736	4,117	3,610
	R (lbs/ft)	4,328	3,571	2,964	2,482	2,099	1,792	1,544	1,341	1,175	1,037
12	Ps (psf)	404	403	386	360	331	302	274	248	225	204
	α (radians)	0.75	0.83	0.90	0.96	1.01	1.06	1.10	1.13	1.16	1.18
	β (radians)	0.38	0.33	0.28	0.24	0.20	0.18	0.15	0.13	0.12	0.11
	z (ft)	6.68	6.97	7.18	7.34	7.46	7.55	7.61	7.67	7.71	7.75
	M (ft-lbs/ft)	27,703	22,237	18,121	14,980	12,550	10,641	9,121	7,895	6,894	6,068
	R (lbs/ft)	5,207	4,424	3,763	3,214	2,762	2,389	2,080	1,823	1,608	1,427
14	Ps (psf)	338	351	349	337	319	298	276	255	234	215
	α (radians)	0.68	0.76	0.83	0.89	0.94	0.99	1.03	1.07	1.10	1.13
	β (radians)	0.38	0.33	0.28	0.25	0.22	0.19	0.17	0.15	0.13	0.12
	z (ft)	7.46	7.85	8.13	8.35	8.51	8.64	8.74	8.82	8.89	8.94
	M (ft-lbs/ft)	38,880	31,856	26,395	22,116	18,729	16,021	13,831	12,043	10,568	9,339
	R (lbs/ft)	5,948	5,178	4,499	3,913	3,414	2,990	2,631	2,327	2,068	1,847
16	Ps (psf)	280	301	310	308	300	286	271	254	237	220
	α (radians)	0.62	0.70	0.77	0.83	0.88	0.93	0.97	1.01	1.04	1.07
	β (radians)	0.36	0.32	0.28	0.25	0.22	0.20	0.18	0.16	0.14	0.13
	z (ft)	8.17	8.64	9.01	9.29	9.51	9.68	9.82	9.93	10.03	10.10
	M (ft-lbs/ft)	51,411	42,880	36,066	30,598	26,183	22,590	19,644	17,207	15,175	13,468
	R (lbs/ft)	6,563	5,829	5,158	4,560	4,034	3,576	3,179	2,837	2,540	2,284

Continued

Depth below top of shoring H <sub>2</sub> (ft)	Variables	Horizontal distance (S) from shoring to track CL measured at a right angle									
		12	14	16	18	20	22	24	26	28	30
18	<b>Ps</b> (psf)	<b>231</b>	<b>256</b>	<b>271</b>	<b>277</b>	<b>276</b>	<b>269</b>	<b>259</b>	<b>247</b>	<b>234</b>	<b>220</b>
	$\alpha$ (radians)	0.57	0.64	0.71	0.77	0.82	0.87	0.92	0.96	0.99	1.02
	$\beta$ (radians)	0.35	0.31	0.28	0.25	0.23	0.20	0.18	0.16	0.15	0.13
	z (ft)	8.80	9.37	9.81	10.16	10.44	10.67	10.85	11.00	11.12	11.22
	M (ft-lbs/ft)	65,062	55,110	46,976	40,313	34,834	30,304	26,536	23,384	20,728	18,477
	R (lbs/ft)	7,072	6,386	5,739	5,145	4,609	4,132	3,710	3,338	3,012	2,725
20	<b>Ps</b> (psf)	<b>191</b>	<b>217</b>	<b>236</b>	<b>246</b>	<b>250</b>	<b>249</b>	<b>244</b>	<b>237</b>	<b>227</b>	<b>217</b>
	$\alpha$ (radians)	0.52	0.59	0.66	0.72	0.77	0.82	0.87	0.91	0.94	0.98
	$\beta$ (radians)	0.33	0.30	0.28	0.25	0.23	0.21	0.19	0.17	0.15	0.14
	z (ft)	9.37	10.03	10.56	10.98	11.32	11.59	11.82	12.01	12.16	12.30
	M (ft-lbs/ft)	79,641	68,368	58,973	51,137	44,586	39,093	34,465	30,548	27,216	24,367
	R (lbs/ft)	7,493	6,859	6,245	5,668	5,135	4,651	4,214	3,822	3,474	3,163
22	<b>Ps</b> (psf)	<b>159</b>	<b>184</b>	<b>204</b>	<b>217</b>	<b>225</b>	<b>228</b>	<b>227</b>	<b>223</b>	<b>217</b>	<b>210</b>
	$\alpha$ (radians)	0.49	0.55	0.62	0.67	0.73	0.77	0.82	0.86	0.90	0.93
	$\beta$ (radians)	0.31	0.29	0.27	0.25	0.23	0.21	0.19	0.17	0.16	0.14
	z (ft)	9.89	10.64	11.24	11.73	12.14	12.47	12.74	12.97	13.17	13.33
	M (ft-lbs/ft)	94,986	82,497	71,913	62,945	55,341	48,878	43,370	38,658	34,611	31,122
	R (lbs/ft)	7,842	7,260	6,684	6,131	5,611	5,128	4,685	4,283	3,918	3,590
24	<b>Ps</b> (psf)	<b>133</b>	<b>157</b>	<b>176</b>	<b>191</b>	<b>202</b>	<b>207</b>	<b>210</b>	<b>209</b>	<b>206</b>	<b>201</b>
	$\alpha$ (radians)	0.45	0.52	0.58	0.63	0.68	0.73	0.78	0.82	0.85	0.89
	$\beta$ (radians)	0.30	0.28	0.26	0.24	0.22	0.20	0.19	0.17	0.16	0.15
	z (ft)	10.35	11.19	11.87	12.44	12.90	13.29	13.62	13.89	14.13	14.32
	M (ft-lbs/ft)	110,969	97,366	85,670	75,625	66,997	59,577	53,183	47,661	42,875	38,716
	R (lbs/ft)	8,132	7,600	7,064	6,540	6,037	5,564	5,122	4,715	4,342	4,001
26	<b>Ps</b> (psf)	<b>112</b>	<b>134</b>	<b>153</b>	<b>168</b>	<b>180</b>	<b>188</b>	<b>192</b>	<b>194</b>	<b>193</b>	<b>191</b>
	$\alpha$ (radians)	0.42	0.48	0.54	0.60	0.65	0.69	0.74	0.78	0.82	0.85
	$\beta$ (radians)	0.28	0.27	0.25	0.23	0.22	0.20	0.19	0.17	0.16	0.15
	z (ft)	10.78	11.69	12.45	13.09	13.62	14.07	14.44	14.77	15.04	15.28
	M (ft-lbs/ft)	127,485	112,863	100,135	89,071	79,460	71,105	63,836	57,499	51,963	47,113
	R (lbs/ft)	8,376	7,890	7,393	6,899	6,418	5,959	5,524	5,118	4,741	4,393
28	<b>Ps</b> (psf)	<b>94</b>	<b>114</b>	<b>132</b>	<b>148</b>	<b>160</b>	<b>169</b>	<b>175</b>	<b>179</b>	<b>180</b>	<b>180</b>
	$\alpha$ (radians)	0.40	0.46	0.51	0.56	0.61	0.66	0.70	0.74	0.78	0.81
	$\beta$ (radians)	0.27	0.26	0.24	0.23	0.21	0.20	0.19	0.17	0.16	0.15
	z (ft)	11.17	12.16	12.99	13.70	14.29	14.80	15.23	15.60	15.91	16.19
	M (ft-lbs/ft)	144,448	128,896	115,211	103,191	92,642	83,385	75,258	68,113	61,823	56,274
	R (lbs/ft)	8,581	8,137	7,677	7,214	6,758	6,315	5,892	5,491	5,115	4,764
30	<b>Ps</b> (psf)	<b>80</b>	<b>98</b>	<b>115</b>	<b>130</b>	<b>142</b>	<b>152</b>	<b>160</b>	<b>165</b>	<b>167</b>	<b>168</b>
	$\alpha$ (radians)	0.37	0.43	0.48	0.53	0.58	0.63	0.67	0.71	0.74	0.78
	$\beta$ (radians)	0.26	0.25	0.23	0.22	0.21	0.20	0.18	0.17	0.16	0.15
	z (ft)	11.52	12.59	13.49	14.26	14.92	15.48	15.97	16.38	16.75	17.06
	M (ft-lbs/ft)	161,789	145,388	130,819	117,903	106,466	96,343	87,381	79,443	72,404	66,153
	R (lbs/ft)	8,755	8,349	7,925	7,492	7,060	6,636	6,227	5,834	5,462	5,112
32	<b>Ps</b> (psf)	<b>69</b>	<b>85</b>	<b>101</b>	<b>115</b>	<b>127</b>	<b>137</b>	<b>145</b>	<b>151</b>	<b>155</b>	<b>157</b>
	$\alpha$ (radians)	0.35	0.41	0.46	0.51	0.55	0.60	0.64	0.68	0.71	0.75
	$\beta$ (radians)	0.25	0.24	0.22	0.21	0.20	0.19	0.18	0.17	0.16	0.15
	z (ft)	11.85	12.98	13.95	14.79	15.51	16.13	16.67	17.13	17.54	17.89
	M (ft-lbs/ft)	179,452	162,274	146,888	133,136	120,859	109,909	100,144	91,432	83,655	76,706
	R (lbs/ft)	8,904	8,532	8,140	7,736	7,329	6,925	6,531	6,150	5,785	5,438

### 5.3 TABLES FOR SOIL SPECIFICATIONS

**Table 8-20-1. Granular Soils**

Descriptive Term for Relative Density	Standard Penetration Test Blows per Foot "N"
Very Loose	0 – 4
Loose	4 – 10
Medium	10 – 30
Dense	30 – 50
Very Dense	Over 50

**Table 8-20-2. Silt and Clay Soils**

Descriptive Term for Consistency	Unconfined Compressive Strength Tons per Square Foot
Very Soft	Less than 0.25
Soft	0.25 – 0.50
Medium	0.50 – 1.00
Stiff	1.00 – 2.00
Very Stiff	2.00 – 4.00
Hard	Over 4.00

**Table 8-20-3. Unit Weights of Soils, and Coefficients of Earth Pressure**

Type of Soil	Unit Weight of Moist Soil, $\gamma$ (Note 1)		Unit Weight of Submerged Soil, $\gamma'$ (Note 1)		Coefficient of Active Earth Pressure, $K_a$				Coefficient of Passive Earth Pressure, $K_p$		
	Minimum	Maximum	Minimum	Maximum	For Backfill	For Soils in Place	Friction Angles (Note 2)		For Soils in Place	Friction Angles (Note 2)	
							$\phi$	$\delta$		$\phi$	$\delta$
(1)	(2)	(3)	(4)	(5)	(6)	(7)	(8)	(9)	(10)	(11)	(12)
Clean Sand:											
Dense	110	140	65	78		0.20	38	20	9.0	38	25
Medium	110	130	60	68		0.25	34	17	7.0	34	23
Loose	90	125	56	63	0.35	0.30	30	15	5.0	30	20
Silty Sand:											
Dense	110	150	70	88		0.25			7.0		
Medium	95	130	60	68		0.30			5.0		
Loose	80	125	50	63	0.50	0.35			3.0		
Silt and Clay (Note 3)	$\frac{165(1+w)}{1+2.65w}$		$\frac{103}{1+2.65w}$		1.00	$1 - \frac{q_u}{\bar{p} + \gamma z}$			$1 + \frac{q_u}{\bar{p} + \gamma z}$		
Note 1:	In pounds per cubic foot.										
Note 2:	These angles, expressed in degrees, are $\phi$ , the angle of internal friction, and $\delta$ , the angle of wall friction, and are used in estimating the coefficients under which they are listed.										
Note 3:	The symbol $\gamma$ represents $\gamma$ or $\gamma'$ , whichever is applicable; $\bar{p}$ is the effective unit pressure on the top surface of the stratum; $q_u$ is the unconfined compressive strength; $w$ is the natural water content, in percentage of dry weight; and $z$ is the depth below the top surface of the stratum.										

## 6. REFERENCES

- a. The following list of references used in these guidelines are placed here in alphabetical order for your convenience.
  - i. AREMA Manual for Railway Engineering, 2019, American Railway Engineering and Maintenance-of-Way Association.
  - ii. Clough and Duncan, 1991, "Earth Pressures," Foundation Engineering Handbook, 2nd Edition, Fang, Chapter 6.
  - iii. CalTrans Trenching and Shoring Manual, 2011, Revision 1, State of California Department of Transportation, Office of Structures Construction.
  - iv. Dismuke, T.D., 1991, "Retaining Structures and Excavations," Foundation Engineering Handbook, 2nd Edition, Fang, Chapter 12.
  - v. FHWA-IF-99-015, Geotechnical Engineering Circular 4, Ground Anchors and Anchored Systems, June 1999, Federal Highway Administration, Office of Bridge Technology.
  - vi. Henkel, D. J., 1971, "The Calculation of Earth Pressures in Open Cuts in Soft Clays." The Arup Journal, Vol. 6, No. 4, pp. 14-15.
  - vii. NAVFAC DM7.02, Foundations and Earth Structures, September 1986, Department of the Navy, Naval Facilities Engineering Command.
  - viii. Terzaghi, K., 1943, Theoretical Soil Mechanics, John Wiley & Sons, Inc., New York, NY.